

**LUDLUM MODEL 2402
POCKET SURVEY METER**

August 2023

**Serial Number 361000 and Succeeding
Serial Numbers**

**LUDLUM MODEL 2402
POCKET SURVEY METER**

August 2023

**Serial Number 361000 and Succeeding
Serial Numbers**



LUDLUM MEASUREMENTS, INC
501 OAK STREET, P.O. BOX 810
SWEETWATER, TEXAS 79556
325-235-5494, FAX: 325-235-4672

STATEMENT OF WARRANTY

Ludlum Measurements, Inc. warrants the products covered in this manual to be free of defects due to workmanship, material, and design for a period of twelve months from the date of delivery. The calibration of a product is warranted to be within its specified accuracy limits at the time of shipment. In the event of instrument failure, notify Ludlum Measurements to determine if repair, recalibration, or replacement is required.

This warranty excludes the replacement of photomultiplier tubes, G-M and proportional tubes, and scintillation crystals which are broken due to excessive physical abuse or used for purposes other than intended.

There are no warranties, express or implied, including without limitation any implied warranty of merchantability or fitness, which extend beyond the description of the face there of. If the product does not perform as warranted herein, purchaser's sole remedy shall be repair or replacement, at the option of Ludlum Measurements. In no event will Ludlum Measurements be liable for damages, lost revenue, lost wages, or any other incidental or consequential damages, arising from the purchase, use, or inability to use product.

RETURN OF GOODS TO MANUFACTURER

If equipment needs to be returned to Ludlum Measurements, Inc. for repair or calibration, please send to the address below. All shipments should include documentation containing return shipping address, customer name, telephone number, description of service requested, and all other necessary information. Your cooperation will expedite the return of your equipment.

**LUDLUM MEASUREMENTS, INC.
ATTN: REPAIR DEPARTMENT
501 OAK STREET
SWEETWATER, TX 79556**

**800-622-0828 325-235-5494
FAX 325-235-4672**

REV #	ALTERATIONS	DATE	BY
1	VALID	4-22-02	JGW
2	UPDATED FRONT PANEL	4-22-06	CMC
3	SCALED "DISCARD" SYMBOL DOWN BY 1/2	4-13-11	CMC

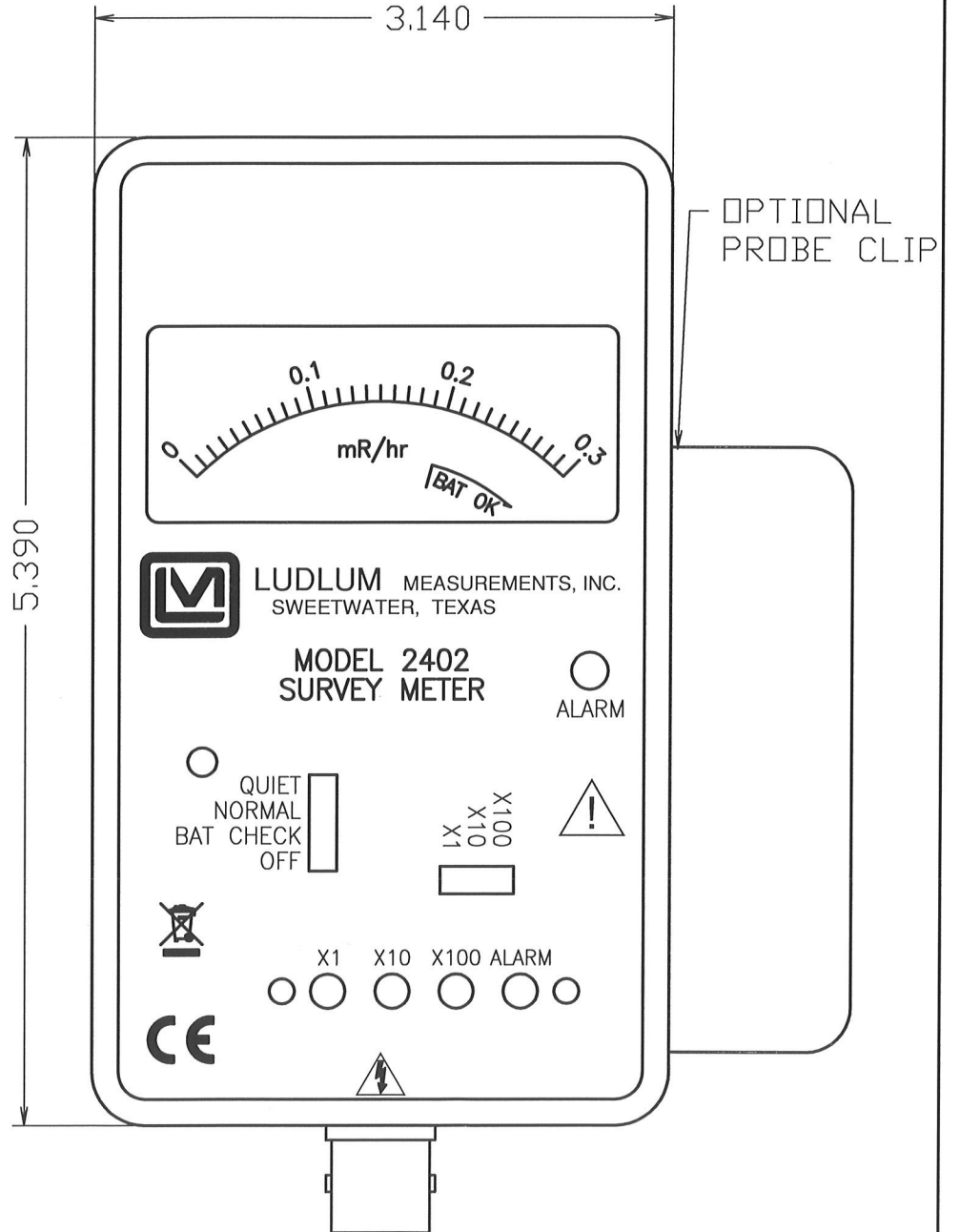
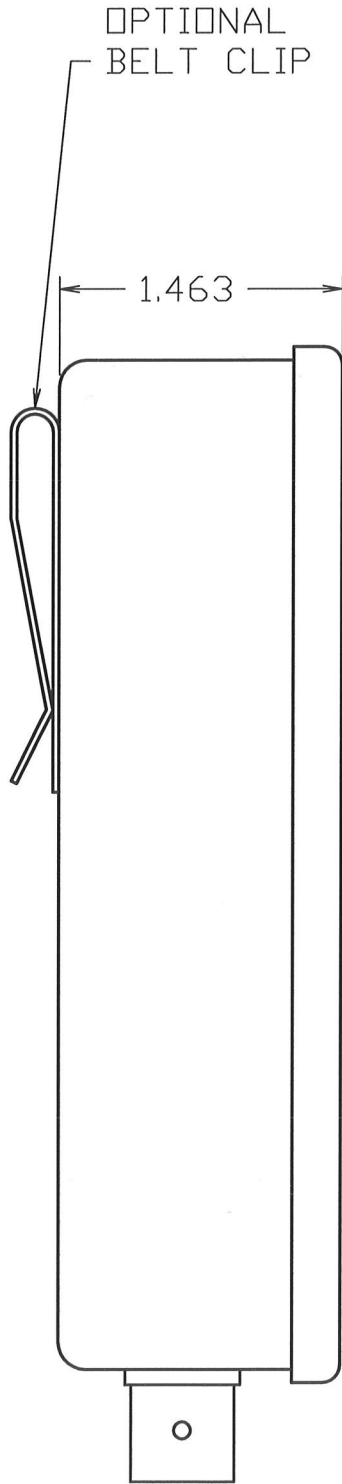

DWN CMC	DATE 4-13-11	CHK CMC	DATE	APP JGW	DATE 4/13/11
PART NUM: 4397-103			SCALE: FULL <input checked="" type="checkbox"/> OTHER		
TITLE M 2402 HANDHELD PORTABLE					
LUDLUM MEASUREMENTS, INC. 501 DAK STREET SWEETWATER, TEXAS 75556			SERIES 397	SHEET 103	

Table of Contents

<i>Introduction</i>	1
<i>Getting Started</i>	2
Unpacking and Repacking	2-1
Battery Installation	2-1
Connecting a Detector to the Instrument	2-2
Battery Test	2-2
Instrument Test	2-2
Operational Check	2-3
<i>Specifications</i>	3
<i>Identification of Controls and Functions</i>	4
<i>Safety Considerations and Maintenance</i>	5
Environmental Conditions for Normal Use	5-1
Warning Markings and Symbols	5-1
Cleaning and Maintenance Precautions	5-2
Maintenance	5-3
Recalibration	5-3
Slide Switches	5-3
<i>Radiation Basics</i>	6
Radiation and Life	6-1
The Unstable Atom	6-2
Radioactive Decay	6-4
Ionizing Radiation	6-5
Measuring Ionizing Radiation	6-6
What are the Health Risks from Ionizing Radiation?	6-7
How Much Ionizing Radiation is Dangerous?	6-8
Background Radiation	6-11
Manmade Radiation	6-12
Protection from Radiation	6-12
Standards and Regulation	6-13
Who is in Charge?	6-13

<i>Troubleshooting</i>	7
Troubleshooting Electronics Which Utilize a G-M or Scintillation Detector	7-1
Troubleshooting GM Detectors	7-3
Troubleshooting Scintillators	7-3
<i>Recycling</i>	8
<i>Parts List</i>	9
Model 2402 Survey Meter	9-1
Main Board, Drawing 397 × 299	9-1
<i>Drawings and Diagrams</i>	10

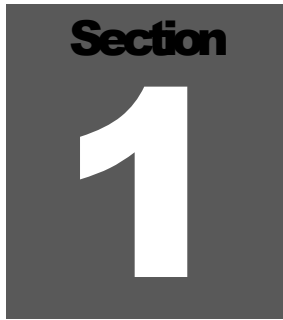
A dark gray square graphic with the word "Section" in white at the top and a large white number "1" in the center.

Introduction

The Model 2402 Pocket Survey Meter is designed to quickly and easily measure ionizing radiation. The instrument may be used with almost any external Geiger-Muller (GM) or scintillation detector. An internal control allows adjustment of the detector operating voltage (HV) which can be adjusted from 550 Vdc to 900 Vdc.

The Model 2402 has a large 2.5-inch analog meter for displaying the radiation level. A three-decade range switch allows the user to switch among the three ranges ($\times 1$, $\times 10$ and $\times 100$). A BAT CHECK position on the selector switch allows the meter to display the battery level. A QUIET position allows the user to turn the click-per-event audio off. Activation of a red ALARM LED and steady tone from the audio speaker indicate an alarm condition when the displayed radiation level has exceeded the set alarm point.

A 9-volt alkaline battery powers the unit. Battery life is typically 250 hours at normal background levels. A steady tone from the audio speaker (whether in NORMAL or QUIET mode) indicates that the battery needs to be changed; proper instrument operation is not guaranteed until the battery is replaced.

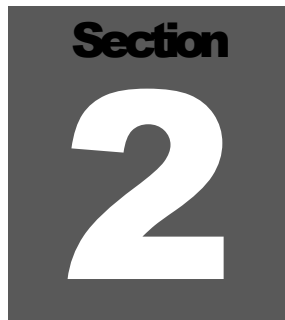
A dark gray square with the word "Section" in white at the top and a large white number "2" in the center.

Getting Started

Unpacking and Repacking

Remove the calibration certificate and place it in a secure location. Remove the instrument and accessories (batteries, cable, detectors, etc.) and ensure that all of the items listed on the packing list are in the carton. Check individual item serial numbers and ensure calibration certificates match. The Model 2402 serial number is located on the left side of the front panel. Most Ludlum Measurements detectors have a label on the base or body of the detector for model and serial number identification.

Important!

If multiple shipments are received, ensure that the detectors and instruments are not interchanged. Each instrument is calibrated to a specific detector(s), and is therefore not interchangeable.

To return an instrument for repair or calibration, provide sufficient packing material to prevent damage during shipment. Also provide appropriate warning labels to ensure careful handling

Every returned instrument must be accompanied by an **Instrument Return Form**, which can be downloaded from the Ludlum website at www.ludlums.com. Find the form by clicking the “Support” tab and selecting “Repair and Calibration” from the drop-down menu. Then choose the appropriate Repair and Calibration division where you will find a link to the form.

Battery Installation

Ensure the instrument selector switch is in the OFF position. Remove the four screws from the back side of the instrument and remove the back housing. Place a 9-volt in the battery holder and press onto the battery

terminals. Replace the instrument housing and screws.

Connecting a Detector to the Instrument

Caution!

The detector operating voltage (HV) is supplied to the detector via the detector input connector. A mild electric shock may occur if bodily contact is made with the center pin of the input connector. Place the Model 2402 selector switch in the OFF position before connecting or disconnecting the cable or detector.

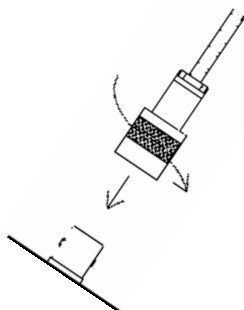

Connect one end of a detector cable to the detector by firmly pushing the connectors together while twisting clockwise $\frac{1}{4}$ turn. Repeat the process in the same manner with the other end of the cable and the instrument.

Battery Test

The battery should be checked each time the instrument is turned on. Slide the selector switch to the BAT CHECK position. Ensure that the meter needle deflects to the battery check portion on the meter scale. If the meter does not respond, check to see if the battery has been correctly installed. Replace the battery if necessary.

Instrument Test

After checking the battery, slide the instrument selector switch to the NORMAL position. Slide the range switch to the $\times 1$ position. A small meter needle deflection will likely occur due to normal background radiation. If the meter needle deflects past full-scale slide the range switch to the next highest range until a reading can be determined. The amount of deflection will depend upon the detector and meter scale used, and the amount of normal background radiation. The instrument speaker should emit a frequency (clicks) relative to the increase in meter reading.

Please set the alarm point(s) on this instrument to conform to your requirements. The factory-set alarm points may be incorrect for your use.

Refer to the instrument manual for more information on setting alarm points.

FAILURE TO RESET THE ALARM POINT(S) MAY RESULT IN EXCESSIVE ALARMS OR LACK OF SENSITIVITY.

Read and then remove the sticker (illustrated to the left) from the instrument. Setting of the alarm-point is described in Section 4 of this manual. The factory setting of the alarm point is noted on the calibration sheet provided with the instrument.

Place the instrument selector switch in the QUIET position and note that the audible clicks are silenced. In order to preserve battery life it is recommended that the instrument selector switch be kept in the QUIET position when the audio function is not needed.

While in an area of normal background radiation, expose the center of the detector to a check source. Ensure the check source reading is within 20% of the reference reading obtained during the last calibration.

If possible, and if not already activated in the previous step, place the range switch in the $\times 1$ position and check for proper function of the alarm indicators by placing the check source in such a way as to drive the meter needle above the alarm set point.

Once this procedure has been completed, the instrument is ready for use.

Operational Check

To assure proper operation of the instrument between calibrations and periods of nonuse, an instrument operational check including battery test and instrument test (as described above) should be performed prior to use. A reference reading with a check source should be obtained at the time of initial calibration or as soon as possible for use in confirming proper instrument operation. In each case, ensure a proper reading on each scale. If the instrument fails to read within 20% of a proper reading, it should be sent to a calibration facility for recalibration.

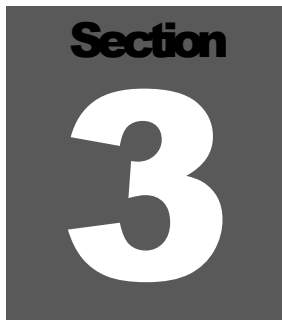
A dark gray square containing the word "Section" in a bold, sans-serif font at the top, and a large, white, stylized number "3" in the center.

Specifications

Typical Detectors:

Alpha Detection: Models 44-7, 44-9, 43-5 and 43-92.

Beta Detection: Models 44-6, 44-7, 44-9 and 44-38.

Gamma Detection: Models 44-6, 44-7, 44-9 and 44-38.

Alpha, Beta and Gamma Detection: Models 44-7 and 44-9.

Sensitivity: -35 mV input pulse.

Operating Voltage: adjustable from 550-900 Vdc; internal HV adjustment potentiometer

Power: one 9-volt alkaline battery; typical life is 250 hours at normal background radiation levels

Response Time: typically 8 seconds from 10% to 90% of the final reading

Accuracy: within 10% of true reading

Meter: 6.4 cm (2.5 in.) arc, 1 mA rugged analog meter

Audio: Speaker emits clicks per radiation event. The sound level is typically 70 dB at 61 cm (2 ft) and can be turned off by placing the selector switch in the QUIET position. The audio speaker also emits a steady tone when the battery level drops, indicating the need for battery replacement. In addition, the speaker works in conjunction with the ALARM LED to indicate an alarm condition.

Alarm: The alarm point may be set from 0 to full-scale meter deflection. Detected radiation in excess of the set alarm point will trigger a red ALARM LED and a steady audible tone whether in NORMAL or QUIET operating mode.

Calibration Controls: Located underneath the calibration cover on the front panel, these potentiometers allow adjustment of the $\times 1$, $\times 10$ and $\times 100$ ranges as well as the ALARM set point.

Size: 4.6 x 8.4 x 13.5 cm (1.8 x 3.3 x 5.3 in.) (H x W x L)

Weight: 0.4 kg (0.9 lb), including battery.

Finish: drawn-and-cast aluminum fabrication, with beige powder coat paint and a recessed subsurface-printed membrane panel

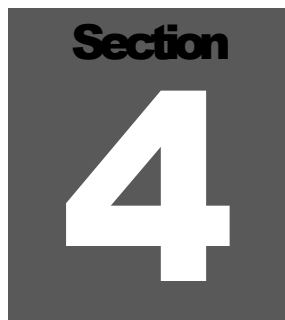
A dark gray square containing the word "Section" in a white sans-serif font at the top, and a large white number "4" in the center.

Identification of Controls and Functions

Meter Face: Meter faces vary depending on the detector used. The actual radiation measurement is determined by multiplying the meter face reading by the multiple associated by the selected position of the range switch.

Important!

Units of exposure rate, such as mR/hr, apply to gamma radiation only. However, exposure rate readings through pancake and end window detectors may be affected by alpha and beta particles if they are not intentionally blocked.

Range Switch: This is a three-position switch marked $\times 1$, $\times 10$, and $\times 100$. Moving the range switch to one of the range multiplier positions ($\times 100$, $\times 10$, $\times 1$) provides the operator with an overall range dependant upon the meter face and detector used. Multiply the scale reading by the multiplier to determine the actual scale reading.

Selector Switch: Sliding the range switch from OFF to BAT CHECK provides the operator with a battery check of the instrument. A BAT OK scale on the meter face provides a visual means of checking the battery-charge status. Placing this switch in the NORMAL position puts the instrument into normal operating mode and energizes the unimorph speaker located on the left side of the instrument. The number of audible clicks is relative to the meter reading; the higher the reading, the more audible clicks. To reduce battery drain, the switch should be placed in the QUIET position when the audio function is not needed.

Alarm Set Point Adjustment: This is a recessed potentiometer located under the front panel calibration cover used to adjust the alarm set point. The point is set by placing the instrument in a field of radiation where the meter reading comes to the desired point of alarm and then adjusting the potentiometer just until the alarm indicators are activated.

Alternatively, a Ludlum Model 500 Pulser (or equivalent) may be used to inject counts, at the detector connector, to the desired meter reading.

Range Calibration Adjustments: These are recessed potentiometers located under the front panel calibration cover which allow for individual calibration of each range multiplier.

HV Adjustment: This is an internal HV potentiometer used to adjust the detector operating voltage (HV). A high voltage meter (with input impedance $\geq 1\text{M Ohm}$) or Ludlum Model 500 Pulser with high voltage display may be used to set the detector operating voltage.

Section
5

Safety Considerations and Maintenance

Environmental Conditions for Normal Use

Indoor or outdoor use.

No maximum altitude (instrument).

Temperature range of -20 to 50 °C (-4 to 122 °F). May be certified for operation from 40 to 65 °C (-40 to 150 °F).

Maximum relative humidity of 95% (non-condensing).

Pollution Degree 3 (as defined by IEC 664) – conductive pollution or dry nonconductive pollution that becomes conductive due to condensation, to be found in industrial environment or construction sites (harsh environment).

Warning Markings and Symbols

Caution!

The operator or responsible body is cautioned that the protection provided by the equipment may be impaired if the equipment is used in a manner not specified by Ludlum Measurements, Inc.

The Model 2402 is marked with the following symbols:



CAUTION, RISK OF ELECTRIC SHOCK (per ISO 3864, No. B.3.6) – designates a terminal (connector) that allows connection to a voltage exceeding 1 kV. Contact with the subject connector while the instrument is on or shortly after turning off may result in electric shock. This symbol appears on the front panel.



CAUTION (per ISO 3864, No. B.3.1) – designates hazardous live voltage and risk of electric shock. During normal use, internal components are hazardous live. This instrument must be isolated or disconnected from the hazardous live voltage before accessing the internal components. This symbol appears on the front panel. **Note the following precautions:**

Warning!

The operator is strongly cautioned to take the following precautions to avoid contact with internal hazardous live parts that are accessible using a tool:

1. Turn the instrument power OFF and remove the battery.
2. Allow the instrument to sit for 1 minute before accessing internal components.



The “**crossed-out wheellie bin**” symbol notifies the consumer that the product is not to be mixed with unsorted municipal waste when discarding; each material must be separated. The symbol is placed on the front panel. See section 8, “Recycling” for further information.



The “CE” mark is used to identify this instrument as being acceptable for use within the European Union.

Cleaning and Maintenance Precautions

Instrument maintenance consists of keeping the instrument clean and periodically checking the battery, slide switches and calibration. The Model 2402 instrument may be cleaned externally with a damp cloth, using only water as the wetting agent. Do not immerse the instrument in any liquid. Observe the following precautions when cleaning or performing maintenance on the instrument:

1. Turn the instrument OFF and remove the battery.
2. Allow the instrument to sit for 1 minute before cleaning the exterior or accessing any internal components for maintenance.

Maintenance

RECALIBRATION

Recalibration should be accomplished after maintenance or adjustment have been performed on the instrument. Recalibration is not normally required following instrument cleaning or battery replacement.

Note:

Ludlum Measurements, Inc. recommends recalibration at intervals no greater than one year. Check appropriate local procedures and regulations to determine required recalibration intervals.

Ludlum Measurements offers a full service repair and calibration department. We not only repair and calibrate our own instruments but most other manufacturer's instruments. Calibration procedures are available upon request for customers who choose to calibrate their own instruments.

SLIDE SWITCHES

Use of the instrument in extremely dusty or dirty environments may cause the slide switches (instrument selector and range switch) to operate erratically. These switches may be restored to proper operation by applying low pressure air to remove the accumulated dirt.

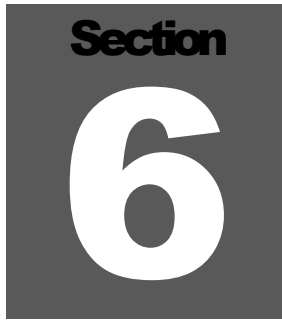
A dark gray square containing the word "Section" in a bold, white, sans-serif font at the top, and a large, white, bold number "6" in the center.

Radiation Basics

Radiation and Life

Adapted from Eric J. Hall's book, "Radiation and Life"

Radiation is energy traveling through space. Sunshine is one of the most familiar forms of radiation. It delivers light, heat and suntans. We control its effect on us with sunglasses, shade, air conditioners, hats, clothes and sunscreen.

There would be no life on earth without lots of sunlight, but we have increasingly recognized that too much of it on our bodies is not a good thing. In fact it may be dangerous, so we control our exposure to it.

Sunshine consists of radiation in a range of wavelengths from long-wave infrared to short-wavelength ultraviolet, which creates the hazard.

Beyond ultraviolet are higher energy kinds of radiation which are used in medicine and which we all get in low doses from space, from the air, and from the earth. Collectively we can refer to these kinds of radiation as **ionizing radiation**. It can cause damage to matter, particularly living tissue. At high levels it is therefore dangerous, so it is necessary to control our exposure.

Background radiation is that which is naturally and inevitably present in our environment. Levels of this can vary greatly. People living in granite areas or on mineralized sands receive more terrestrial radiation than others, while people living or working at high altitudes receive more cosmic radiation. A lot of our natural exposure is due to radon, a gas which seeps from the earth's crust and is present in the air we breathe.

The Unstable Atom

Radiation comes from atoms, the basic building blocks of matter.

Most atoms are stable; a carbon-12 atom, for example, remains a carbon-12 atom forever, and an oxygen-16 atom remains an oxygen-16 atom forever, but certain atoms eventually disintegrate into a totally new atom. These atoms are said to be 'unstable' or 'radioactive'. An unstable atom has excess internal energy, with the result that the nucleus can undergo a spontaneous change towards a more stable form. This is called 'radioactive decay'.

When an atom of a radioisotope decays, it gives off some of its excess energy as radiation in the form of gamma rays or fast-moving sub-atomic particles. One can describe the emissions as gamma, beta and alpha radiation.

Apart from the normal measures of mass and volume, the amount of radioactive material is given in **curie** (Ci), a measure which enables us to compare the typical radioactivity of some natural and other materials.

Radioactivity of some natural and other materials

1 adult human (2.7×10^{-9} Ci/kg)	1.89×10^{-7} Ci
1 kg (2.2 lb) of coffee	2.70×10^{-8} Ci
1 kg (2.2 lb) of super phosphate fertilizer	1.35×10^{-7} Ci
The air in a 100 m ² (1076 ft ²) Australian home (radon)	8.12×10^{-8} Ci
The air in many 100 m ² (1076 ft ²) European homes (radon)	8.12×10^{-7} Ci
1 household smoke detector (with americium)	8.12×10^{-7} Ci
Radioisotope for medical diagnosis	1.89×10^3 Ci
Radioisotope source for medical therapy	2702.7 Ci
1 kg (2.2 lb) of 50-year old vitrified high-level nuclear waste	270.27 Ci
1 luminous Exit sign (1970s)	27.027 Ci
1 kg (2.2 lb) of uranium	675.68×10^6 Ci
1 kg (2.2 lb) of uranium ore (Canadian, 15%)	675.68×10^6 Ci

1 kg (2.2 lb) of uranium ore (Australian, 0.3%)	13.51×10^6 Ci
1 kg (2.2 lb) of low-level radioactive waste	27.03×10^6 Ci
1 kg (2.2 lb) of coal ash	5.41×10^{-8} Ci
1 kg (2.2 lb) of granite	2.70×10^{-8} Ci

NB. Though the intrinsic radioactivity is the same, the radiation dose received by someone handling a kilogram of high grade uranium ore will be much greater than for the same exposure to a kilogram of separated uranium, since the ore contains a number of short-lived decay products (see section on Radioactive Decay).

Radioactive Decay

Atoms in a radioactive substance decay in a random fashion but at a characteristic rate. The length of time this takes, the number of steps required and the kinds of radiation released at each step are well known.

**URANIUM 238 (U238)
RADIOACTIVE DECAY**

type of radiation	nuclide	half-life
	uranium-238	4.47 billion years
α	↓	
	thorium-234	24.1 days
β	↓	
	protactinium-234m	1.17 minutes
β	↓	
	uranium-234	245000 years
α	↓	
	thorium-230	8000 years
α	↓	
	radium-226	1600 years
α	↓	
	radon-222	3.823 days
α	↓	
	polonium-218	3.05 minutes
α	↓	
	lead-214	26.8 minutes
β	↓	
	bismuth-214	19.7 minutes
β	↓	
	polonium-214	0.000164 seconds
α	↓	
	lead-210	22.3 years
β	↓	
	bismuth-210	5.01 days
β	↓	
	polonium-210	138.4 days
α	↓	
	lead-206	stable

The half-life is the time taken for half of the atoms of a radioactive substance to decay. Half-lives can range from less than a millionth of a second to millions of years, depending upon the element concerned. After one half-life the level of radioactivity of a substance is halved, after two half-lives it is reduced to one quarter, after three half-lives to one-eighth and so on.

All uranium atoms are mildly radioactive. The following figure for uranium-238 shows the series of different radioisotopes it becomes as it decays, the type of radiation given off at each step and the 'half-life' of each step on the way to stable, non-radioactive lead-206. The shorter-lived each kind of radioisotope, the more radiation

it emits per unit mass. Much of the natural radioactivity in rocks and soil comes from this decay chain.

Ionizing Radiation

Here we are concerned mainly with ionizing radiation from the atomic nucleus. It occurs in two forms, rays and particles, at the high frequency end of the energy spectrum.

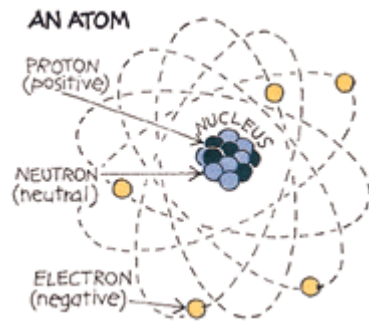

There are several types of ionizing radiation:

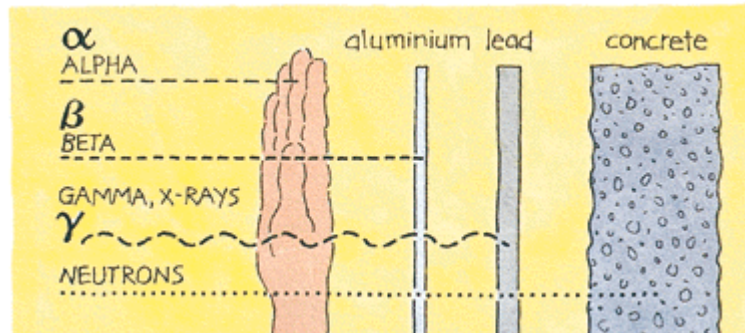

X-rays and gamma rays, like light, represent energy transmitted in a wave without the movement of material, just as heat and light from a fire or the sun travel through space. X-rays and gamma rays are virtually identical, except that X-rays are generally produced artificially rather than coming from the atomic nucleus. Unlike light, X-rays and gamma rays have great penetrating power and can pass through the human body. Thick barriers of concrete, lead or water are used as protection from them.

Alpha particles consist of two protons and two neutrons, in the form of atomic nuclei. They thus have a positive electrical charge and are emitted from naturally occurring heavy elements such as uranium and radium, as well as from some man-made elements. Because of

their relatively large size, alpha particles collide readily with matter and lose their energy quickly. They therefore have little penetrating power and can be stopped by the first layer of skin or a sheet of paper.

However, if alpha sources are taken into the body, for example by breathing or swallowing radioactive dust, alpha particles can affect the body's cells. Inside the body, because they give up their energy over a relatively short distance, alpha particles can inflict more severe biological damage than other radiations.

Beta particles are fast-moving electrons ejected from the nuclei of atoms. These particles are much smaller than alpha particles and can penetrate up to 5/64 of an inch of water or human flesh. Beta particles are emitted from many radioactive elements. They can be stopped by a sheet of aluminum a few millimeters thick.

Neutrons are particles which are also very penetrating. On Earth they mostly come from the splitting, or fissioning, of certain atoms inside a nuclear reactor. Water and concrete are the most commonly used shields against neutron radiation from the core of the nuclear reactor.

Note:

It is important to understand that alpha, beta, gamma and X-radiation do not cause the body, or any object around the source, to become radioactive. However, most materials in their natural state (including body tissue) contain measurable amounts of radioactivity.

Measuring Ionizing Radiation

RAD and REM

The human senses cannot detect radiation or discern whether a material is radioactive. However, a variety of instruments can detect and measure radiation reliably and accurately.

The amount of ionizing radiation, or 'dose', received by a person is measured in terms of the energy absorbed in the body tissue, and is expressed in **RAD**. One rad is 0.01 joules deposited per kilogram of mass.

Equal exposure to different types of radiation expressed as RAD, do not however, necessarily produce equal biological effects. One rad of alpha radiation, for example, will have a greater effect than one rad of beta radiation. When we talk about radiation effects, we therefore express the radiation as effective dose, in a unit called the **REM** (Roentgen Equivalent Man).

Regardless of the type of radiation, one rem of radiation produces the same biological effect. (100 rem = 1 Sv)

Smaller quantities are expressed in 'mrem' (one thousandth) or 'µrem' (one millionth of a rem). We will use the most common unit, rem, here.

What Are The Health Risks From Ionizing Radiation?

It has been known for many years that large doses of ionizing radiation, very much larger than background levels, can cause a measurable increase in cancers and leukemias ('cancer of the blood') after some years delay. It must also be assumed, because of experiments on plants and animals, that ionizing radiation can also cause genetic mutations that affect future generations, although there has been no evidence of radiation-induced mutation in humans. At very high levels, radiation can cause sickness and death within weeks of exposure - see Table (on next page).

But what are the chances of developing cancer from low doses of radiation? The prevailing assumption is that any dose of radiation, no matter how small, involves a possibility of risk to human health. However there is no scientific evidence of risk at doses below approximately 5 rem in a short period of time or about 10 rem over a period of one year.

Higher accumulated doses of radiation might produce a cancer which would only be observed several - up to twenty - years after the radiation exposure. This delay makes it impossible to say with any certainty which of many possible agents were the cause of a particular cancer. In western countries, about a quarter of people die from cancers, with smoking, dietary factors, genetic factors and strong sunlight being among the main causes. Radiation is a weak carcinogen, but undue exposure could certainly increase health risks.

On the other hand, large doses of radiation directed specifically at a tumor are used in radiation therapy to kill cancerous cells, and thereby often save lives (usually in conjunction with chemotherapy or surgery). Much larger doses are used to kill harmful bacteria in food, and to sterilize bandages and other medical equipment. Radiation has become a valuable tool in our modern world.

How Much Ionizing Radiation is Dangerous?

Radiation levels and their effects

The following table gives an indication of the likely effects of a range of whole body radiation doses and dose rates to individuals:

1,000 rem as a short-term and whole-body dose would cause immediate illness, such as nausea and decreased white blood cell count, and subsequent death within a few weeks.

Between 200 and 1000 rem in a short-term dose would cause severe radiation sickness with increasing likelihood that this would be fatal.

100 rem in a short term dose is about the threshold for causing immediate radiation sickness in a person of average physical attributes, but would be unlikely to cause death. Above 100 rem, severity of illness increases with dose.

If doses greater than 100 rem occur over a long period they are less likely to have early health effects but they create a definite risk that cancer will develop many years later.

Above about **10 rem**, the probability of cancer (rather than the severity of illness) increases with dose. The estimated risk of fatal cancer is 5 of every 100 persons exposed to a dose of 100rem (ie. if the normal incidence of fatal cancer were 25%, this dose would increase it to 30%).

5 rem is, conservatively, the lowest dose at which there is any evidence of cancer being caused in adults. It is also the highest dose which is allowed by regulation in any one year of occupational exposure. Dose rates greater than 5 rem/yr arise from natural background levels in several parts of the world but do not cause any discernible harm to local populations.

2 rem/yr averaged over 5 years is the limit for radiological personnel such as employees in the nuclear industry, uranium or mineral sands miners and hospital workers (who are all closely monitored).

1 rem/yr is the maximum actual dose rate received by any Australian uranium miner.

300-500 mrem/yr is the typical dose rate (above background) received by uranium miners in Australia and Canada.

300 mrem/yr (approx) is the typical background radiation from natural sources in North America, including an average of almost 200 mrem/yr from radon in air.

200 mrem/yr (approx) is the typical background radiation from natural sources, including an average of 70mrem/yr from radon in air. This is close to the minimum dose received by all humans anywhere on Earth.

30-60 mrem/yr is a typical range of dose rates from artificial sources of radiation, mostly medical.

5 mrem/yr, a very small fraction of natural background radiation, is the design target for maximum radiation at the perimeter fence of a nuclear electricity generating station. In practice, the actual dose is less.

What is the risk estimate?

According to the Biological Effects of Ionizing Radiation committee V (BEIR V), the risk of cancer death is 0.08% per rem for doses received rapidly (acute) and might be 2-4 times (0.04% per rem) less than that for doses received over a long period of time (chronic). These risk estimates are an average for all ages, males and females, and all forms of cancer. There is a great deal of uncertainty associated with the estimate.

Risk from radiation exposure has been estimated by other scientific groups. The other estimates are not the exact same as the BEIR V estimates, due to differing methods of risk and assumptions used in the calculations, but all are close.

Risk comparison

The real question is: how much will radiation exposure increase my chances of cancer death over my lifetime.

To answer this, we need to make a few general statements of understanding. One is that in the US, the current death rate from cancer is approximately 20 percent, so out of any group of 10,000 United States citizens, about 2,000 of them will die of cancer. Second, that contracting cancer is a random process,

where given a set population, we can estimate that about 20 percent will die from cancer, but we cannot say *which* individuals will die. Finally, that a conservative estimate of risk from low doses of radiation is thought to be one in which the risk is linear with dose. That is, that the risk increases with a subsequent increase in dose. Most scientists believe that this is a conservative model of the risk.

So, now the risk estimates: If you were to take a large population, such as 10,000 people and expose them to one rem (to their whole body), you would expect approximately eight additional deaths ($0.08\% \times 10,000 \times 1 \text{ rem}$). So, instead of the 2,000 people expected to die from cancer naturally, you would now have 2,008. This small increase in the expected number of deaths would not be seen in this group, due to natural fluctuations in the rate of cancer.

What needs to be remembered is that it is not known that 8 people will die, but that there is a risk of 8 additional deaths in a group of 10,000 people if they would all receive 1rem instantaneously.

If they would receive the 1 rem over a long period of time, such as a year, the risk would be less than half this (<4 expected fatal cancers).

Risks can be looked at in many ways. Here are a few ways to help visualize risk:

One way often used is to look at the number of "days lost" out of a population due to early death from separate causes, then dividing those days lost between the population to get an "Average Life expectancy lost" due to those causes. The following is a table of life expectancy lost for several causes:

Health Risk	Est. life expectancy lost
Smoking 20 cigarettes a day	6 years
Overweight (15%)	2 years
Alcohol (US Avg.)	1 year
All Accidents	207 days
All Natural Hazards	7 days
Occupational dose (300 mrem/yr)	15 days
Occupational dose (1 rem/yr)	51 days

You can also use the same approach to looking at risks on the job:

Industry Type	Est. life expectancy lost
All Industries	60 days
Agriculture	320 days
Construction	227 days
Mining and quarrying	167 days
Manufacturing	40 days
Occupational dose (300 mrem/yr)	15 days
Occupational dose (1 rem/yr)	51 days

These are estimates taken from the NRC Draft guide DG-8012 and were adapted from B.L. Cohen and I.S. Lee, "Catalogue of Risks Extended and Updates", *Health Physics*, Vol. 61, September 1991.

Another way of looking at risk, is to look at the Relative Risk of 1 in a million chances of dying of activities common to our society:

Smoking 1.4 cigarettes (lung cancer)
Eating 40 tablespoons of peanut butter
Spending 2 days in New York City (air pollution)
Driving 40 miles in a car (accident)
Flying 2500 miles in a jet (accident)
Canoeing for 6 minutes
Receiving 10 mrem of radiation (cancer)

Adapted from DOE Radiation Worker Training, based on work by B.L. Cohen, Sc.D.

Background Radiation

Naturally occurring background radiation is the main source of exposure for most people. Levels typically range from about 150-350 mrem per year but can be more than 5rem/yr. The highest known level of background radiation affecting a substantial population is in Kerala and Madras States in India where some 140,000 people receive doses which average over 1.5 rem/year from gamma radiation, in addition to a similar dose from radon. Comparable levels occur in Brazil and Sudan, with average exposures up to about 4 rem/yr to many people.

Several places are known in Iran, India and Europe where natural background radiation gives an annual dose of more than 5 rem and up to 26 rem (at Ramsar in Iran). Lifetime doses from natural radiation range

up to a couple thousand rem. However, there is no evidence of increased cancers or other health problems arising from these high natural levels.

Manmade Radiation

Ionizing radiation is also generated in a range of medical, commercial and industrial activities. The most familiar and, in national terms, the largest of these sources of exposure is medical X-rays.

Natural radiation contributes about 88% of the annual dose to the population and medical procedures most of the remaining 12%. Natural and artificial radiations are not different in kind or effect.

Protection from Radiation

Radiation is very easily detected. There is a range of simple, sensitive instruments capable of detecting minute amounts of radiation from natural and man-made sources. There are three ways in which people are protected from identified radiation sources:

Limiting time: For people who are exposed to radiation in addition to natural background radiation through their work, the dose is reduced and the risk of illness essentially eliminated by limiting exposure time. Proper job planning is essential in achieving lowest exposure time. Always plan for the unexpected to eliminate delays in the exposure area.

Distance: In the same way that heat from a fire is less the further away you are, so the intensity of radiation decreases with distance from its source. Distance is the easiest, fastest and most practical way to limit exposure.

Shielding: Barriers of lead, concrete or water give good protection from penetrating radiation such as gamma rays. Highly radioactive materials are therefore often stored or handled under water, or by remote control in rooms constructed of thick concrete or lined with lead.

Standards and Regulation

Much of the evidence which has led to today's standards derives from the atomic bomb survivors in 1945, which were exposed to high doses incurred in a very short time. In setting occupational risk estimates, some allowance has been made for the body's ability to repair damage from small exposures, but for low-level radiation exposure the degree of protection may be unduly conservative.

Most countries have their own systems of radiological protection which are often based on the recommendations of the International Commission on Radiological Protection (ICRP). The 'authority' of the ICRP comes from the scientific standing of its members and the merit of its recommendations.

Who is in charge?

Ultimately, you are. All of the sources of radiation, other than natural, are regulated by laws passed by Congress. Like any other law, you have your right to voice your views and opinions about it. The regulations that control the use of radioactivity in our country are based upon recommendations of science organizations like the International Commission on Radiological Protection (ICRP), the National Council on Radiation Protection (NCRP), the International Atomic Energy Agency (IAEA), the United Nations (UN), and the Health Physics Society (HPS). Governing bodies like the Environmental Protection Agency (EPA), the Nuclear Regulatory Commission (NRC), the Department of Energy (DOE), and the Food and Drug Administration (FDA) review these recommendations and propose the regulations that industry and government must follow. These are then passed by Congress, if found to be acceptable, and published in the Code of Federal Regulations (CFRs).

Note:

The CFR limits the general public to radiation exposure of 100 mrem/year, with no more than 2 mrem of exposure in any one hour (ref. 10 CFR 20.1301).

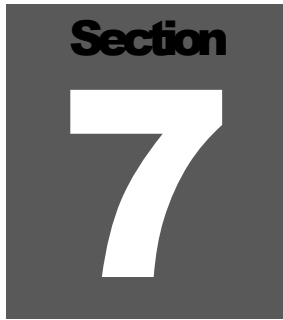

Troubleshooting

Occasionally, you may encounter problems with your LMI instrument or detector that may be repaired or resolved in the field, saving turnaround time and expense in returning the instrument to us for repair. Toward that end, LMI electronics technicians offer the following tips for troubleshooting the most common problems. Where several steps are given, perform them in order until the problem is corrected. Keep in mind that with this instrument, the most common problems encountered are: (1) detector cables, and (2) sticky meters.

Note that the first troubleshooting tip is for determining whether the problem is with the electronics or with the detector. A Ludlum Model 500 Pulser is invaluable at this point, because of its ability to simultaneously check high voltage, input sensitivity or threshold, and the electronics for proper counting.

We hope these tips will prove to be helpful. As always, please call if you encounter difficulty in resolving a problem or if you have any questions.

Troubleshooting Electronics which utilize a GM or Scintillation Detector

<u>SYMPTOM</u>	<u>POSSIBLE SOLUTION</u>
No power (or meter does not reach BAT TEST or BAT OK mark)	<ol style="list-style-type: none"> 1. Check the battery and replace if weak. 2. Check for loose or broken wires.

<u>SYMPTOM</u>	<u>POSSIBLE SOLUTION</u>
Nonlinear Readings	<ol style="list-style-type: none">1. Check the high voltage (HV). If a multimeter is used to check the HV, ensure that one with high impedance is used, as a standard multimeter could be damaged in this process.2. Check for noise in the detector cable by disconnecting the detector, placing the instrument on the lowest range setting and wiggling the cable while observing the meter face for significant changes in readings.3. Check for “sticky” meter movement. Does the reading change when you tap the meter? Does the meter needle “stick” at any spot?4. Check the “meter zero.” Turn the power OFF. The meter should come to rest on “0.”
Meter goes full scale or “Pegs Out”	<ol style="list-style-type: none">1. Replace the detector cable to determine whether or not the cable has failed, causing excessive noise.2. Check the HV, and if possible, the input threshold for proper setting.3. Check for loose wires.
No Response to Radiation	<ol style="list-style-type: none">1. Substitute a “known good” detector and/or cable.2. Has the correct operating voltage been set? Refer to the calibration certificate or detector instruction manual for correct operating voltage. If the instrument uses multiple detectors, confirm that the

<u>SYMPTOM</u>	<u>POSSIBLE SOLUTION</u>
No Response to Radiation (cont.)	high voltage is matched to the current detector being used.
No Audio	1. Ensure that the selector switch is in the NORMAL position.

Troubleshooting GM Detectors

1. If the tube has a thin mica window, check for window breakage. If damage is evident, the tube must be replaced.
2. Check the HV. For most GM tubes, the voltage is normally 900 Vdc, or 460-550 Vdc for “peanut” tubes (Ludlum Model 133 series).
3. If the input sensitivity is too low, the user could see some double-pulsing.
4. Wires to the tube may be broken or the crimped connector could have a loose wire.

Troubleshooting Scintillators

1. Alpha or Alpha/Beta scintillators are prone to light leaks. They can be tested for this problem in a dark room or with a bright light. If a light leak is determined, changing the metallized polyester window assembly will usually fix the problem.

Note:

When replacing the window, make sure to use a window made with the same thickness metallized polyester and the same number of layers as the original window.

2. Verify that the HV and input sensitivity are correct. Alpha and gamma scintillators typically operate from 10-35 mV. High voltage varies with the photomultiplier tubes (PMT) from as low as 600 Vdc, to as high as 1400 Vdc.

3. On a gamma scintillator, visually inspect the crystal for breakage or humidity leakage. Water inside the crystal will turn it yellow and gradually degrade performance.
4. Check the PMT to see if the photocathode still exists. If the end of the PMT is clear (not brownish), this indicates a loss of vacuum which will render the PMT useless.

Section 8

Recycling

Ludlum Measurements, Inc. supports the recycling of the electronics products it produces for the purpose of protecting the environment and to comply with all regional, national and international agencies that promote economically and environmentally sustainable recycling systems. To this end, Ludlum Measurements, Inc. strives to supply the consumer of its goods with information regarding reuse and recycling of the many different types of materials used in its products. With many different agencies, public and private, involved in this pursuit it becomes evident that a myriad of methods can be used in the process of recycling. Therefore, Ludlum Measurements, Inc. does not suggest one particular method over another, but simply desires to inform its consumers of the range of recyclable materials present in its products, so that the user will have flexibility in following all local and federal laws.

The following types of recyclable materials are present in Ludlum Measurements, Inc. electronics products, and should be recycled separately. The list is not all-inclusive, nor does it suggest that all materials are present in each piece of equipment:

Batteries	Glass	Aluminum and Stainless Steel
Circuit Boards	Plastics	Liquid Crystal Display (LCD)

Ludlum Measurements, Inc. products, which have been placed on the market after August 13, 2005, have been labeled with a symbol recognized internationally as the “crossed-out wheelee bin.” This notifies the consumer that the product is not to be mixed with unsorted municipal waste when discarding; each material must be separated. The symbol is placed on the instrument front panel and appears as such:



 A dark gray square containing the word "Section" in a bold, sans-serif font at the top, and a large white number "9" in the center.

Parts List

	<u>Reference</u>	<u>Description</u>	<u>Part Number</u>
Model 2402 Survey Meter	UNIT	Completely Assembled Model 2402 Survey Meter	48-3087
Main Board, Drawing 397 × 299	BOARD	Completely Assembled Main Circuit Board	5397-299
CAPACITORS	C001-C002	0.001 μ F, 2KV	04-5703
	C003-C006	470PF, 1KV	04-5693
	C008	10 μ F, 20V	04-5655
	C009	0.001 μ F, 2KV	04-5703
	C0011	10PF, 100V	04-5673
	C011-C015	470PF, 1KV	04-5693
	C021	470PF, 100V	04-5668
	C031	10 μ F, 20V	04-5655
	C101	0.0015 μ F, 100V	04-5680
	C102	1 μ F, 35V	04-5656
	C121	100PF, 3KV	04-5735
	C141	68 μ F, 6.3V	04-5654
	C201	0.01 μ F, 50V	04-5664
	C202	0.001 μ F, 100V	04-5659
	C211	270PF, 100V	04-5679
	C212	0.022 μ F, 50V	04-5667
	C231	10 μ F, 20V	04-5655
TRANSISTORS	Q011	MTD2N50	05-5855
	Q021	2N7002L	05-5840
	Q201	LT1460KCS3-2.5	05-5867
	Q211	2N7002L	05-5840

	<u>Reference</u>	<u>Description</u>	<u>Part Number</u>
INTEGRATED CIRCUITS	U021	ICM7555CBA	06-6300
	U041	MAX639AESA	06-7123
	U101	MAX641BCSA	06-6388
	U102	HFA3096BZ96	06-6468
	U111	TLC27M7ID	06-6292
	U201	MAX985EUK	06-6459
	U211	CD74HC4066M	06-6323
	U212	CD74HC4538M	06-6297
	U231	HFA3096BZ96	06-6468
	LED	DS121	ALARM, HLMP4700
DIODES	CR001-CR002	CMPD2004S	07-6402
	CR011-CR013	CMPD2004S	07-6402
	CR031-CR032	CMSH1-40M	07-6411
	CR101	CMPD2004S	07-6402
SWITCHES	S111	OFF-ON-BAT-QUIET	08-6483
	S112	RANGE	08-6484
POTENTIOMETERS	R011	1M, HV	09-6906
	R101	1M, ×1 ADJ	09-6911
	R108	1M, ×10 ADJ	09-6911
	R203	100K, ALARM ADJ.	09-6930
	R1010	100K, ×100 ADJ	09-6930
	RESISTORS	R003	1.00M, 125mW, 1%
R004		100K, 125mW, 1%	12-7834
R005-R006		1.00M, 125mW, 1%	12-7844
R007		100K, 125mW, 1%	12-7834
R008		332K, 250mW, 1%	12-7976
R009		1.00M, 125mW, 1%	12-7844
R021		475K, 125mW, 1%	12-7859
R022		1.00K, 125mW, 1%	12-7832
R041		475K, 125mW, 1%	12-7859
R042		165K, 125mW, 1%	12-7877
R102-R103		10.0K, 125mW, 1%	12-7839
R104		1.00K, 125mW, 1%	12-7832
R105		10.0K, 125mW, 1%	12-7839
R106		4.75K, 125mW, 1%	12-7858
R107		100K, 250mW, 5%	12-7972
R109		10.0K, 125mW, 1%	12-7839

	<u>Reference</u>	<u>Description</u>	<u>Part Number</u>
	R111	1.00M, 125mW, 1%	12-7844
	R112-R113	100K, 125mW, 1%	12-7834
	R114	301, 125mW, 1%	12-7863
	R115	33.2K, 125mW, 1%	12-7842
	R121	1G	12-7686
	R201	100, 125mW, 1%	12-7840
	R202	4.75K 125mW, 1%	12-7858
	R204-R205	100K, 125mW, 1%	12-7834
	R206	12.1K, 125mW, 1%	12-7879
	R207	100K, 125mW, 1%	12-7834
	R211	665K, 250mW, 1%	12-7977
	R212-R213	100K, 125mW, 1%	12-7834
	R214-R215	1.00M, 125mW, 1%	12-7844
	R221	1.00K, 125mW, 1%	12-7832
	R222	1.00M, 125mW, 1%	12-7844
	R231	10.0K, 125mW, 1%	12-7839
	R232	475K, 125mW, 1%	12-7859
	R1011	1.00K, 125mW, 1%	12-7832
	R1012	10.0K, 125mW, 1%	12-7839
INDUCTORS	L001	470 μ HY	21-9699
	L021	220 μ HY	21-9678
	L131	150 μ HY	21-9677
MISCELLANEOUS	P1	CONNECTOR-640456-2 MTA100 \times 2, METER	13-8073
	J1-J2	CONTACT #1414	18-9124
	DS011	UNIMORPH	21-9782
	B121	BATTERY HOLDER	22-9404
MISCELLANEOUS ASSEMBLY COMPONENTS	*	FP & METER ASSY.	4397-117
	*	Battery, Alkaline, 9V	21-9282
	1 ea.	Cable, series "C" 39-inch	40-1004
	*	Model 2402 CAN	7397-116
	*	Harness, Model 2402 Can	8397-120
	1 ea.	Unimorph Gasket	7397-063
	1 ea.	Switch Slot Long Cover	7397-272
	1 ea.	Switch Slot Short Cover	7397-273
	1 ea.	Model 2401-EC20 CAL SCN	9397-297

A dark gray square graphic with the word "Section" in a bold, black, sans-serif font at the top. Below it, the number "10" is written in a very large, bold, white, sans-serif font.

Drawings

Main Circuit Board Schematic, Drawing 397 × 299 (2 sheets)

Main Circuit Board Component Layout, Drawing 397 × 302 (2 sheets)

A

B

C

D

E

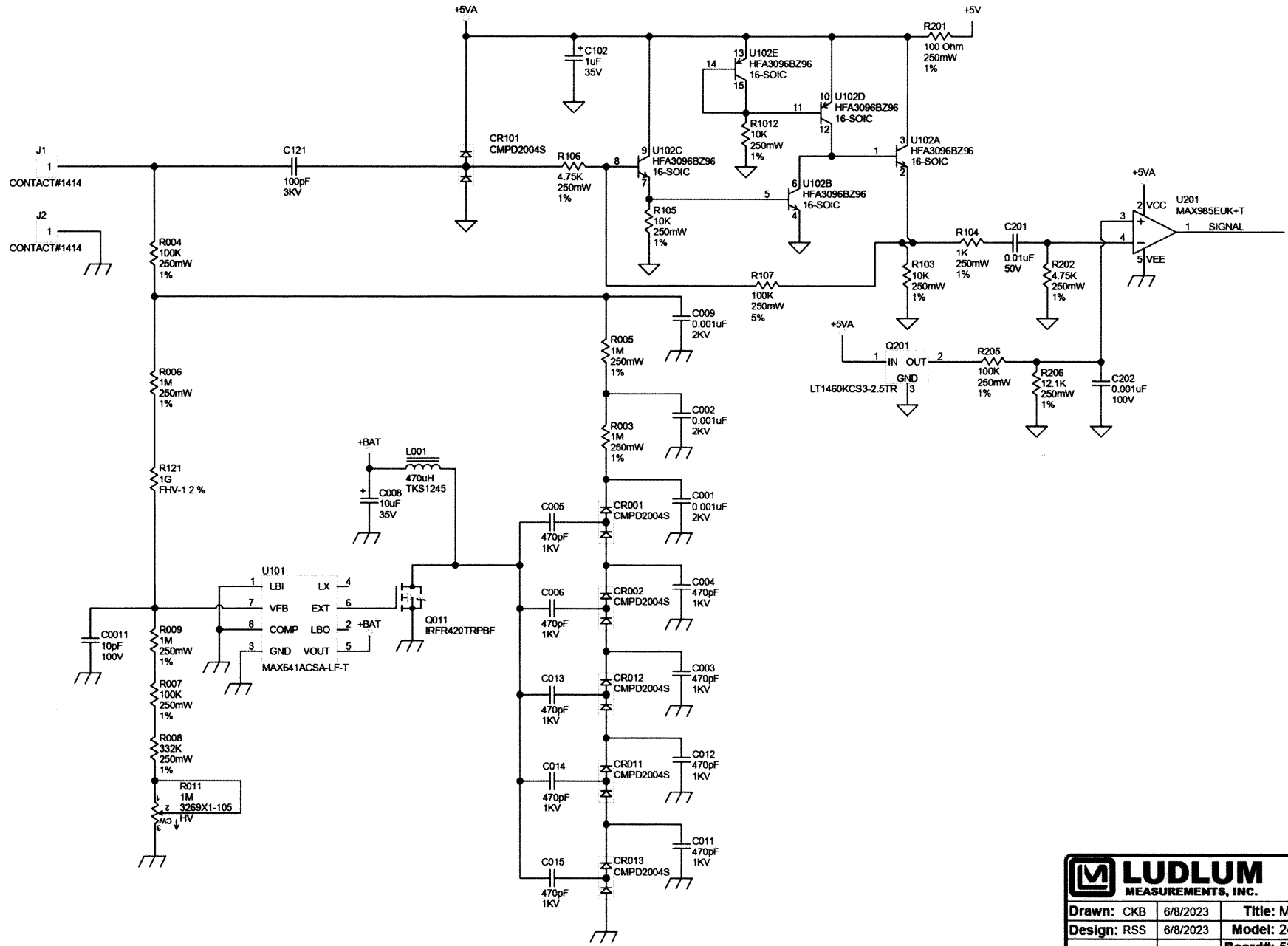

		PO Box 810 501 Oak Street Sweetwater, Texas 79556 U.S.A. 1-800-622-0628	
		Drawn: CKB Design: RSS	Title: Main Board Model: 2402 Board#: 5397-299
Approve:		Sheet: 1 of 2 Rev: 2	Print Date: 6/9/2023 4:00:44 PM
<small>Wreedomlpcb/Project/LMMW 2402/5397-299/Rev/2397299R2P1.SchDoc</small>			

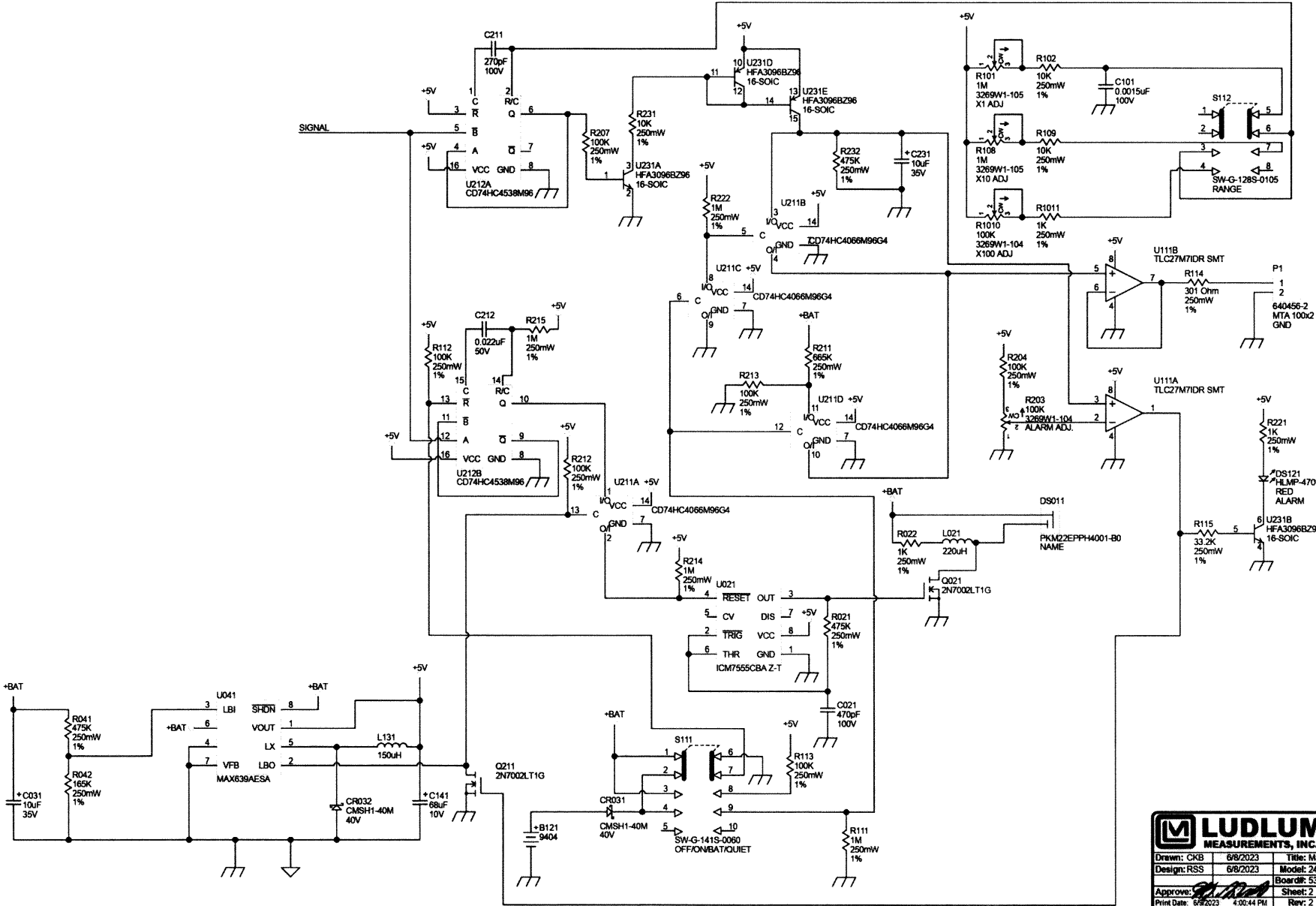

		PO Box 810 501 Oak Street Sweetwater, Texas 79556 U.S.A. 1-800-622-0828	
		Design: CKB Design: RSS	Title: Main Board Model: 2402 Board#: 5397-299
Approve: Print Date: 6/8/2023 4:00:44 PM	Rev: 2	397	299

Top Layer (Scale 2:1)

5397-299
REV: 2

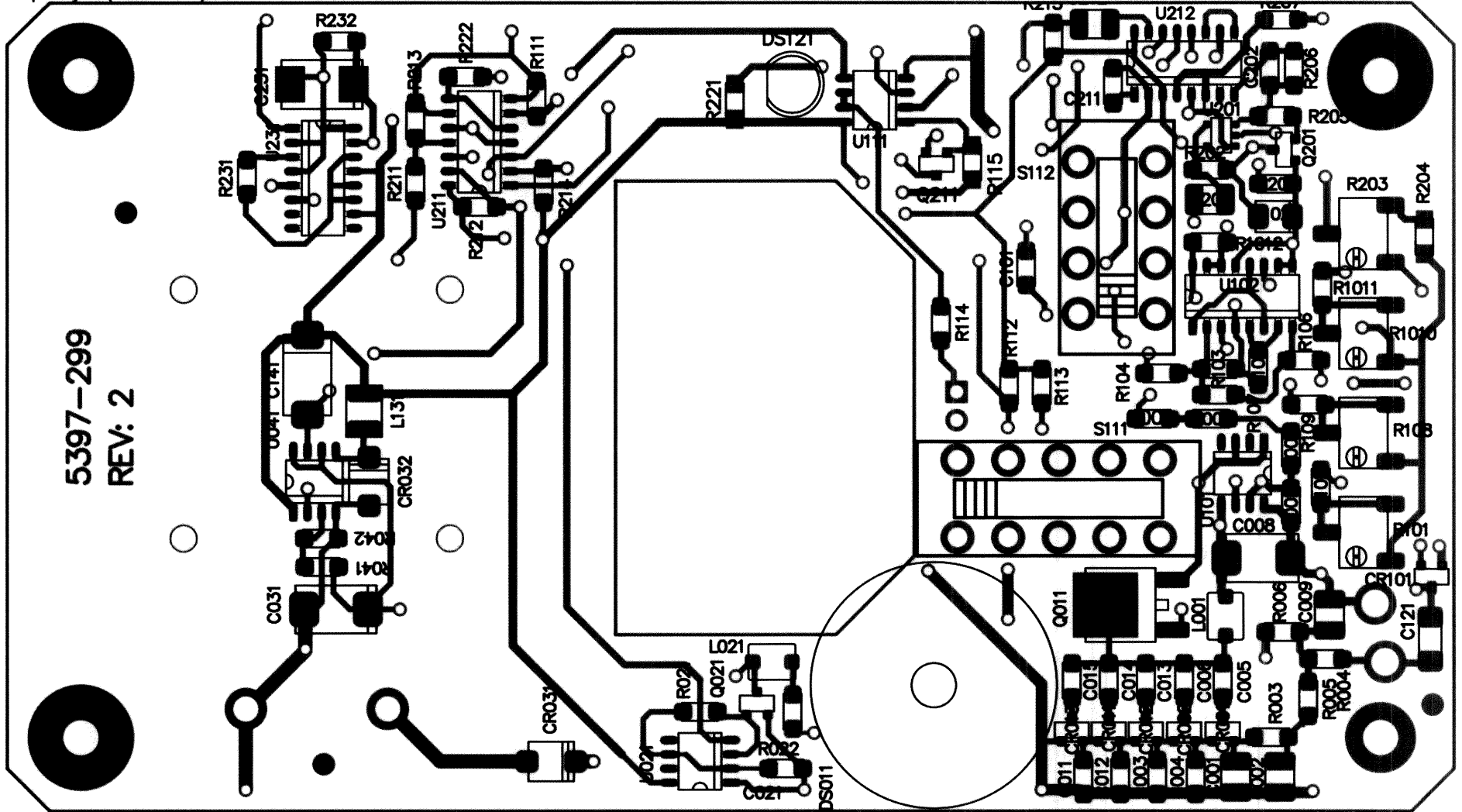

M LUDLUM MEASUREMENTS				
Part: 5397-299		Model: 2402		
Desc: Main Board				
Design: RSS	Date: 6/8/2023	Rev:	2	
Drawn: PAB	Date: 6/8/2023	SHEET	SERIES	SHEET
Apr: <i>PAB</i>	Date: <i>12/2023</i>	1 of 3	397	302
\\freedom\pcb\Projects\LM\MM 2402\5397-299\Rev2				

Bottom Layer (Scale 2:1)

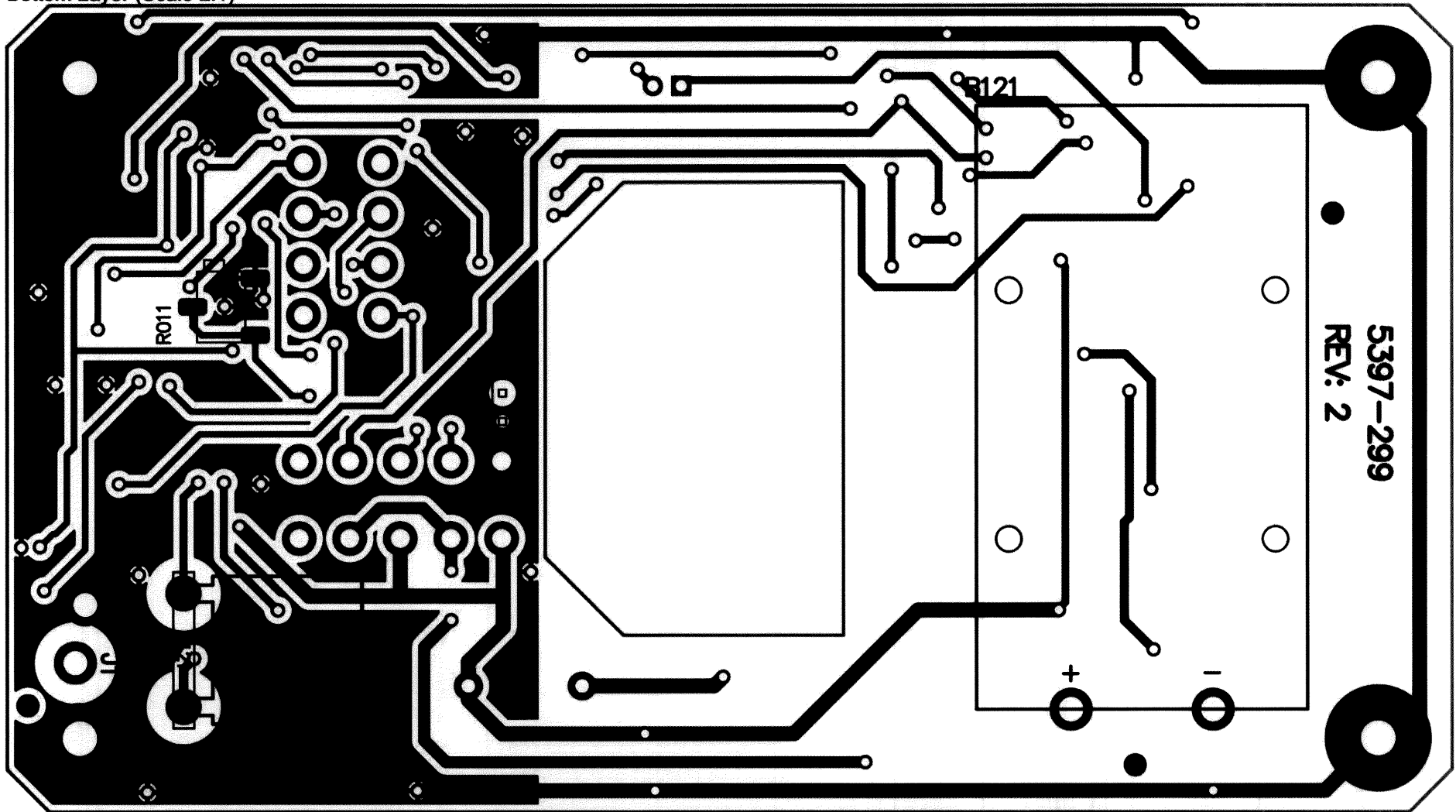

 LUDLUM MEASUREMENTS				
Part: 5397-299			Model: 2402	
Desc: Main Board				
Design: RSS	Date: 6/8/2023	Rev:	2	
Drawn: PAB	Date: 6/8/2023	SHEET	SERIES	SHEET
Apr: <i>RSS</i>	Date: <i>12/20/23</i>	2 of 3	397	302
\\freedom\pcb\Projects\LM\MM 2402\5397-299\Rev2				